

Operation Manual

True Match® Firmware 4.0

(Camera)

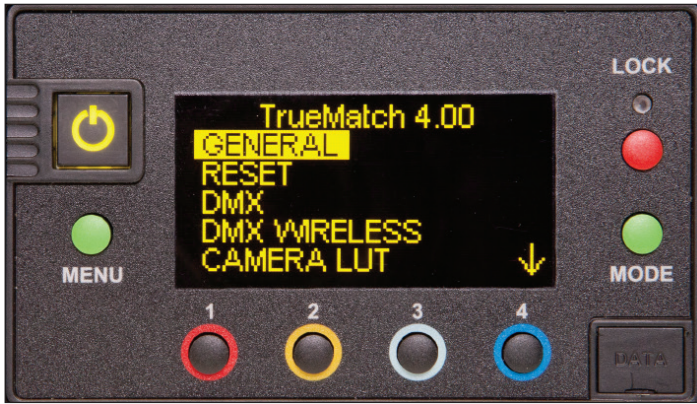

**Celeb, Diva-Lite, FreeStyle
Image, Select**



True Match® Firmware 4.0 (Camera)

This operation manual is for the following Kino Flo LED products using **True Match® Firmware 4.0**. Although the Customer interface is the same on all models listed, there are component differences. For this reason, it is very important that the correct Firmware is loaded to the corresponding model.



The following products use **True Match® Firmware 4.0 DFS**:

Diva-Lite LED = Version 4.0 DFS
FreeStyle LED Controllers
Image LED = Version 4.0 DFS
Select LED Controllers

The Celeb products use the corresponding
True Match® Firmware 4.0 CEL2, CEL4 or CEL8:

Celeb 250 LED = Version 4.0 CEL2
Celeb 450/450Q LED = Version 4.0 CEL4
Celeb 850 LED = Version 4.0 CEL8

Menu Overview

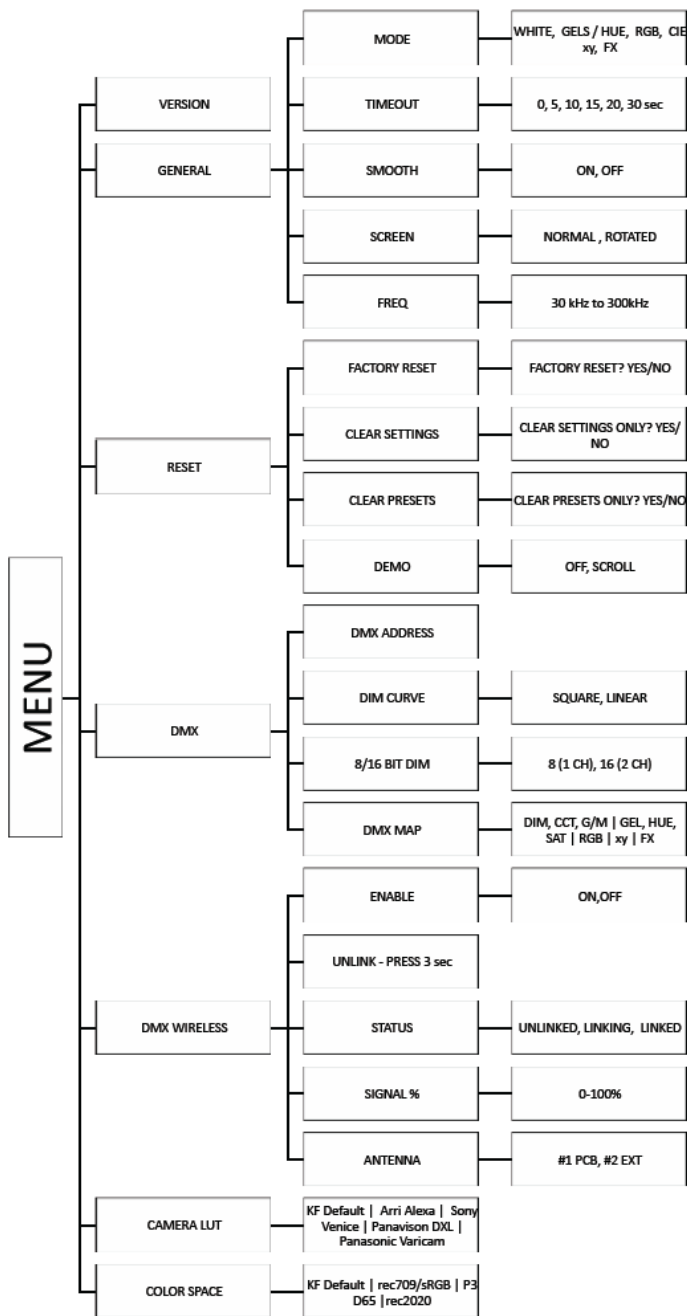

Control Panel - White Mode

FreeStyle LED 151 DMX Controller shown for example purposes.



- A) On /Off:** **On** = Green light displayed. **Off** = Red light displayed. The display and all menu settings can be operated while the power button is in the Off position, as long as power is applied to the controller. The On /Off button only controls the light source.
- B) Menu:** Provides access to menu options such as General settings, Reset, DMX, DMX Wireless, Camera LUT and Color Space.
Shortcut: While on control screen, press and hold for 3 seconds to switch through menus (**White, Gels & Hue, RGB, CIE xy** and **FX**).
- C) Preset Buttons:** Factory defaults left to right are: 2700K, 3200K, 5000K and 6500K. G/M default value is 000. User can also use these preset buttons to store custom Kelvin and G/M settings.
- D) Display:** Provides access to Dim, Kelvin, G/M, and DMX channel.
Factory reset will show: Dim = 10%, Kelvin = 2700K, G/M = 000, DMX = 001.
- E) Lock:** Press the **Lock** button to disable all buttons and Control knob.
Press for 3 seconds to restore displayed presets to default factory settings.
- F) Mode:** Press to navigate from Dim to Kelvin and G/M settings.
When in sub-menus, pressing Mode always returns you to main display.
When DMX is applied, use Mode to access DMX channel on main display.
Shortcut: Long press will bring you back one step.
- G) Data Port:** Mini B USB for firmware updates.
- H) Control Knob:** Manually adjusts Dim, Kelvin, G/M levels and DMX address.
Press the Control knob to toggle between **Fine** and **Coarse** increments or when selecting options within menus.

DMX Note: Each LED Fixture has an **"AUTO TERMINATE"** feature. The last fixture that does not have an XLR cable attached to the DMX "Out" port will automatically terminate.

Dimming



Press the Mode button to select **Dim**. Rotating the control knob will dim the light of the fixture. Default setting is Fine. Press the Control knob to toggle between **Fine** and **Coarse** increments or when selecting options within menus. When the power is turned off or removed, the display will remember its last setting.

Note: Pressing Mode always takes you to a Mode screen.
Pressing Menu always takes you to a Menu screen.



The default setting for **DIM** is that smoothing is on. When smoothing is on, it introduces a time lag such that the individual dimming steps are less noticeable. However, when working in DMX and instant response is required, it is recommended that smoothing be turned off. The ***DIM** designates that the smoothing function is off.

Note: When in **FX** mode, the smoothing on/off has no effect other than in **TV** mode.

Kelvin Selection/Presets



Press the Mode button until **Kelvin** is highlighted.

In White mode, Kelvin custom settings are between 2700K to 6500K and displayed G/M can be assigned to any preset button by holding down the desired button for 3 seconds. The Kelvin display will flash once the setting is registered.

Default Presets 1-4:

- 1 = 2700K
- 2 = 3200K
- 3 = 5000K
- 4 = 6500K

Rotating the Control knob will change the Kelvin. Default setting is **Fine**. Press the Control knob to toggle between **Fine** and **Coarse** increments or when selecting options within menus.

Green/Magenta



Press the Mode button until **G/M** is highlighted. Rotating the control knob to the right will adjust towards Green. Rotating to the left will adjust towards Magenta. Default setting is Fine. Press the Control knob to toggle the G/M from **Fine** to **Coarse** increments.

Green/Magenta Chart

100G	+1 Green
50G	+½ Green
25G	+¼ Green
25M	+¼ Magenta
50M	+½ Magenta
100M	+1 Magenta

The LED software features a **G/M** (Green/Magenta) control to match the spectral sensitive curves of most popular cameras and other light sources.

Lock



Press the **Lock** button to lock the Dim, Kelvin and G/M setting (Applies to White, Gels/Hue, RGB, FX or CIE xy Modes). A red indicator light will display in Lock mode. Manual controls will be disabled. To unlock, press the Lock button again. The red indicator will turn off.

Shortcut: The Lock button also has a secondary function. Hold the Lock button down for 3 seconds and the presets 1-4 will be restored to factory settings for the Mode currently displayed.

Control Panel - Gels/Hue Mode



Gels/Hue Mode

A) Menu:

Provides access to menu options such as General settings (**Gels/Hue Mode**), Reset, DMX and DMX Wireless Camera LUT and Color Space.

Shortcut: While on control screen, press and hold for 3 seconds to switch through menus (**White, Gels & Hue, RGB, CIE xy and FX**).

B) Preset Buttons:

Factory defaults left to right are: 2700K, 3200K, 5000K and 6500K.

G/M default value is 000. User can also use these preset buttons to store custom Kelvin between 2500K and 9900K and custom G/M, Gel, Hue and Saturation settings.

C) Display:

Provides access to Dim, Kelvin, G/M, Gel, Hue/Saturation and DMX channel. Factory reset will show: Dim = 10%, Kelvin = 2700K, G/M = 000, DMX = 001.

D) Mode:

Press to navigate from Dim to Kelvin, G/M, Gel, Hue and Saturation settings. When on the Gel function, pushing the Control knob in/out will apply the gel or remove the gel. When in sub-menus, pressing Mode always returns you to main display. When DMX is applied, use Mode to access DMX channel on main display. Shortcut Tip: Long press will bring you back one step.

Gel, Hue Angle & Saturation



In **Gels/Hue** mode (in addition to **G/M** control), **Gel**, **Hue** angle and **Saturation** adjustments are available. Kino Flo Presets and industry standard preset Gels are included. Press Menu, select General and press control knob to change Mode to Gels/Hue.



Gel

Press the Mode button until **Gel** is highlighted. Rotate the dimming knob to choose Kino Flo presets and preset Gels. When on the Gel function, pushing the Control knob in/out will apply the gel or remove the gel. For DMX protocol for preset Gels, see www.kinoflo.com.

Hue Angle and Saturation

Press the Mode button until **Hue** or **Saturation** is highlighted. Rotate the dimming knob to select custom Hue angle and Saturation. Press the knob to toggle between **Fine** and **Coarse** adjustments.

The **Hue** angle and **Saturation** values are based on a HSV / RGB model where 0° = Red, 120° = Green and 240° = Blue.

In **Gels/Hue** mode, **Kelvin** custom settings between 2500K to 9900K and displayed **G/M**, **Gel** or **Hue** angle and **Saturation** can be assigned to any preset button by holding down the desired button for 3 seconds. The Kelvin display will flash once the setting is registered.

To restore presets to default factory settings, choose **Reset** under **General** settings and **Clear Presets**. This method will reset all buttons in all modes. Shortcut: If only want to clear presets for individual display, hold **Lock** button for 3 seconds.

Control Panel - RGB Mode

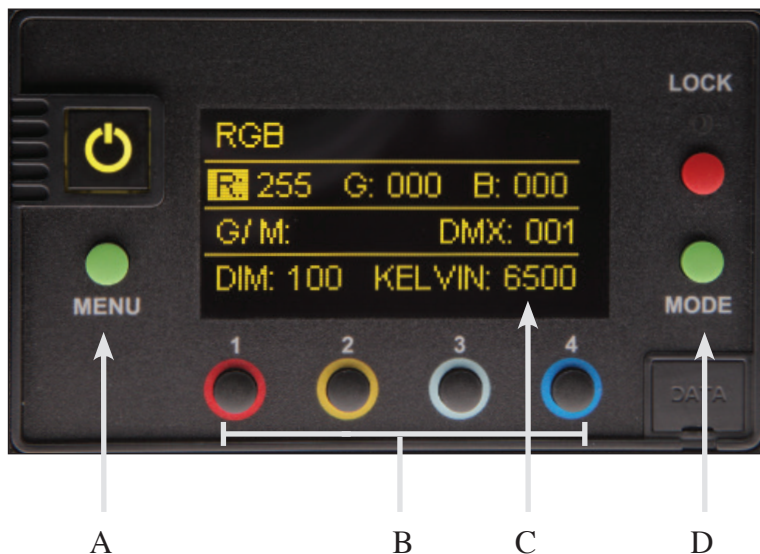

RGB Mode

A) Menu:

Provides access to menu options such as General settings (**RGB Mode**), Reset, DMX and DMX Wireless Camera LUT and Color Space.
Shortcut: While on control screen, press and hold for 3 seconds to switch through menus (**White, Gels & Hue, RGB, CIE xy and FX**).

B) Preset Buttons:

Factory defaults left to right are: 2700K, 3200K, 5000K and 6500K.
G/M default value is 000. User can also use these preset buttons to store custom Kelvin between 2500K and 9900K and custom G/M, and RGB settings.

C) Display:

Provides access to Dim, Kelvin, G/M, RGB and DMX channel.
Factory reset will show: Dim = 10%, Kelvin = 2700K, G/M = 000, DMX = 001.

D) Mode:

Press to navigate from Dim to Kelvin, G/M, RGB settings.
When in sub-menus, pressing Mode always returns you to main display.
When DMX is applied, use Mode to access DMX channel on main display.
Shortcut: Long press will bring you back one step.

RGB



In **RGB Color** mode (in addition to G/M control), individual RGB (Red, Green, Blue) adjustments are available. Press Menu, select General and press control knob to change Mode to RGB.

RGB

Press the Mode button until R (Red), G (Green) or B (Blue) is highlighted. Rotate the Control knob to choose individual RGB settings. Press the Control knob to toggle between **Fine** and **Coarse** increments.

In **RGB Mode**, **Kelvin** custom settings between 2500K to 9900K and displayed RGB values can be assigned to any preset button by holding down the desired button for 3 seconds. The Kelvin display will flash once the setting is registered.

To restore presets to default factory settings, choose **Reset** under **General** settings and **Clear Presets**. This method will reset all buttons in all Modes. Shortcut: If only want to clear presets for an individual display, hold Lock button for 3 seconds.

Control Panel - CIE xy

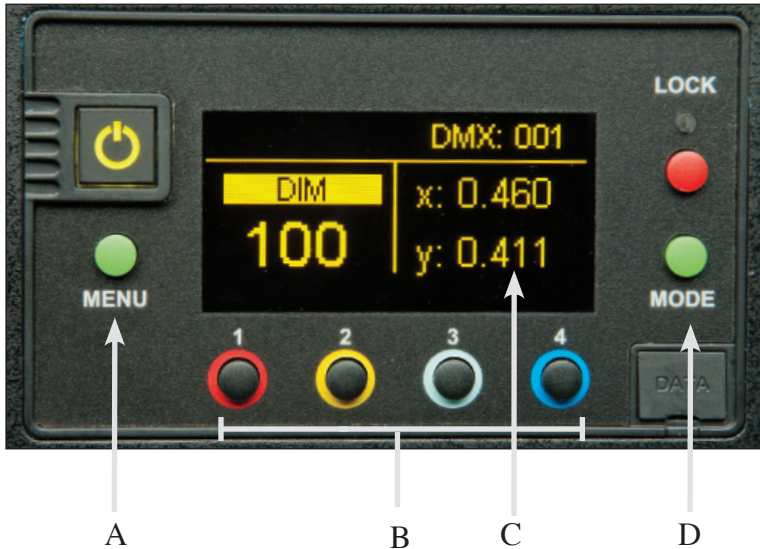

CIE xy Mode

A) Menu:

Provides access to menu options such as General settings (**CIE xy mode**), Reset, DMX, DMX Wireless, Camera LUT and Color Space.
Shortcut: While on control screen, press and hold for 3 seconds to switch through menus (**White, Gels & Hue, RGB, CIE xy** and **FX**).

B) Preset Buttons:

Factory defaults left to right are: 2700K, 3200K, 5000K and 6500K.
User can also use these preset buttons to store custom xy settings.

C) Display:

Provides access to Dim, CIE xy coordinates and DMX Channel.
Factory reset will show: Dim = 10%, x = 0.460 , y = 0.411, G/M = 000, DMX = 001.

D) Mode:

Press to navigate from Dim to xy settings. When in sub-menus, pressing Mode always returns you to main display. When DMX is applied, use Mode to access DMX channel on main display. Shortcut: Long press will bring you back one step.

To restore presets to default factory settings, choose **Reset** under **General** settings and **Clear Presets**. This method will reset all buttons in all Modes. Shortcut: If only want to clear presets for an individual display, hold Lock button for 3 seconds.

Control Panel - FX (Effects)



FX (Effects)

A) Menu:

Provides access to menu options such as General settings (**FX Mode**), Reset, DMX and DMX Wireless Camera LUT and Color Space. Shortcut: While on control screen, press and hold for 3 seconds to switch through menus (**White, Gels & Hue, RGB, CIE xy and FX**).

B) Mode:

After selecting General menu and choosing FX Mode, press the green Mode button to access specific effects and navigate options.

True Match Firmware 4.0 includes an FX (Effects) menu with 8 modes of operation. Within each mode, there are also pre-programmed "Types" to provide variation.

Additional controls are also provided to manipulate the functions to your specific requirements. In addition, each mode has 4-memory buttons to store custom effects.

The FX Modes are:

1. Candle
2. Fire
3. TV
4. Police
5. Lightning
6. Paparazzi
7. Pulse
8. Scroll

FX (Effects)

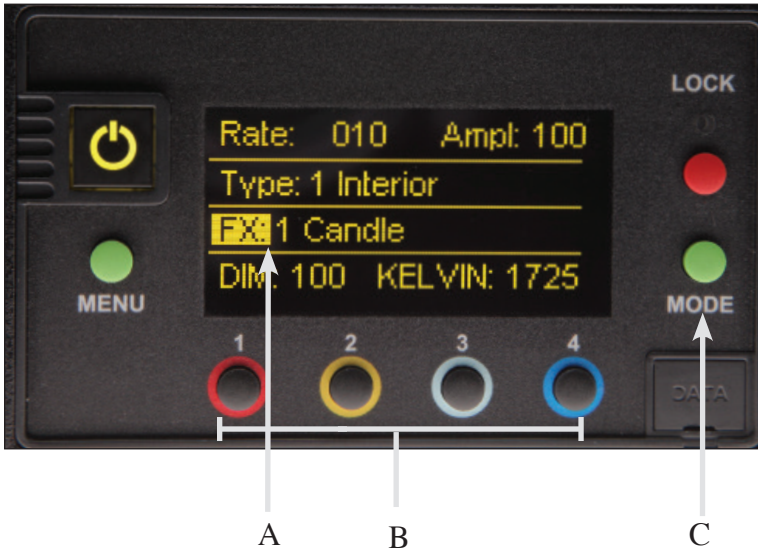

FX (Effects) Mode

FX mode provides access to effects including Candle, Fire, TV, Police, Lightning, Paparazzi, Pulse and Scroll. Candle mode used as an example:

A) FX Option:

Choose the desired FX Mode by rotating the control knob. When on the desired effect, there will be several pre-programmed effects as well as control parameters that can be altered.

B) Preset Buttons:

In FX Mode, **Kelvin** custom settings and any control functions displayed such as **Rate** and **Amplitude (Ampl)** can be saved as a preset. Chosen values can be assigned to any preset button by holding down the desired button for 3 seconds. The Kelvin display will flash once the setting is registered.

To restore presets to default factory settings, choose **Reset** under **General** settings and **Clear Presets**. This method will reset all buttons in all Modes. Shortcut: If only want to clear presets for **Candle** Mode, hold **Lock** button for 3 seconds while Candle mode is displayed.

C) Mode:

Press to navigate from Dim to Kelvin and FX settings.
Shortcut: Long press will bring you back one step.

Control Panel - Candle Mode



1 Candle Mode

Candle mode is to simulate a candle flame. In addition to dimming, the Kelvin can be set to a Kelvin range of 1400- 2500 Kelvin. Set the Kelvin range to a mid-point of the candle color of your choice and the candle color will change +/- 200 Kelvin.

There are 2 Types of candle flame pre-programmed, **Interior** and **Breeze**. Interior is a candle flicker and Breeze is candle flicker with larger jumps in brightness.

The control parameters are **Rate** (1 to 20 Rate of flicker) and **Amplitude (Ampl)**. Amplitude scale is 1 to 100 with 100 equaling largest brightness change.

Control Panel - Fire Mode



2 Fire Mode

Fire mode is to simulate a fire flame. In addition to dimming, the Kelvin can be set to a Kelvin range of 1400- 2500 Kelvin. Set the Kelvin range to a mid-point of the fire color of your choice and the fire color will change +/- 200 Kelvin.

There are 2 Types of fire mode pre-programmed, **Firepit** and **Gas Fireplace**.

The control parameters are **Rate** (1 to 20 Rate of flicker) and **Amplitude (Ampl)**. Amplitude scale is 1 to 100 with 100 equaling largest brightness change.

Control Panel - TV Mode



3 TV Mode

The TV Mode is to simulate a TV effect. In addition to dimming, the Kelvin can be set to a Kelvin range of 2500K to 9900K. The default Kelvin is 6500K.

There are 3 Types TV effect pre-programmed: **Movie**, **Music Video** and **Sports**. Movie has similar color change to TV and movie scenes. Music Video has larger color and brightness changes similar to music video or action with rapid edits. Sports has more saturated colors in greens and blues similar to sporting arenas.

The control parameters are **Rate** (1 to 20 Rate of flicker) and **Amplitude (Ampl)**. Amplitude scale is 1 to 100 with 100 equaling largest brightness change.

Control Panel - Police Mode



4 Police Mode

The Police mode is to simulate Police or emergency vehicles. In addition to dimming, the Kelvin can be set to a Kelvin range of 2500K to 9900K. The default Kelvin for the pre-programmed types is 6500K.

There are 5 Types of Police effects, mainly categorized by the color or color combination:

1 Blue + Red	Blue (Pause) Red
2 Red	Red
3 Yellow	Yellow
4 Blue + White + Red	Blue (Pause) White (Pause) Red
5 Blue	Blue

The control parameters are **Burst** and **Rate**. Bursts are the number of bursts (scale is 1-4) per color and Rate of bursts is 1 to 100 with 100 equaling fastest change.

Control Panel - Lightning Mode



5 Lightning Mode

The **Lightning Mode** is to simulate lightning effect. In addition to dimming, the Kelvin can be set to a Kelvin range of 2500K to 9900K. The default Kelvin for the pre-programmed types is 6500K.

There are 2 types of lightning effects **Storm** and **Frankenstein**. The Storm effect is to simulate a thunderstorm and Frankenstein has more intense, brighter flashes.

There is one control parameter which is **Rate** that is scaled between 1 to 20 with 20 having the most variation in the lighting sequences.

Note: If you want to trigger or cue a lightning effect, can use the power button to start the lighting sequence. When power button is triggered, the pattern/sequence will repeat each time the power button is used.

Control Panel - Paparazzi Mode



6 Paparazzi Mode

The Paparazzi Mode is to simulate photographic flashes. In addition to dimming, the Kelvin can be set to a Kelvin range of 2500K to 9900K. The default Kelvin for the pre-programmed types is 6500K.

There are 2 types of Paparazzi, **Red Carpet** and **Stalker**. Red Carpet has very quick, frequent, and random flashes. Stalker has less frequent flashes (more pause between flashes).

Paparazzi has 2 Parameters **Rate** and **Flash**. The Rate is scaled 1 to 100 with 100 being the fastest. The Flash is also scaled 1 to 100 with flash length of 100 being the longest.

Note: If you want to trigger or cue a flash effect, set to **Stalker** and use the power button to start the flash sequence. When power button is triggered, the pattern/sequence will repeat each time the power button is used.

Control Panel - Pulse Mode

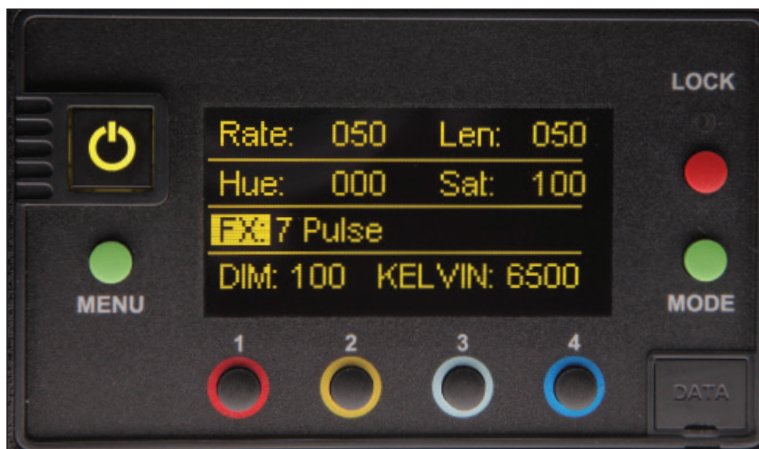

7 Pulse Mode

The **Pulse** mode is to simulate a repeating color – such as a flashing neon sign or emergency lighting. In addition to dimming, the Kelvin can be set to a Kelvin range of 2500K to 9900K. The default Kelvin is 6500K.

There are no pre-programmed types in Pulse mode. The control parameters are:

Hue

The Hue Angle scale is 0° to 360°.

The **Hue** angle and **Saturation** values are based on a HSV / RGB model where 0° = Red, 120° = Green and 240° = Blue.

Sat

Saturation of pulsed color scale is 0 to 100 with 0 = white and 100 = fully saturated

Rate

Rate of pulse is scale from 1 to 100, with 100 being highest rate.

Len

Length of pulse is scale 1 to 100 as follows:

- 1-49 = Light is less on
- 50 = Light is equal on / off
- 51-100 = Light is more on

Control Panel - Scroll Mode



8 Scroll Mode

The Scroll mode is to simulate color changing light over a period of time. In addition to dimming, the Kelvin can be set to a Kelvin range of 2500K to 9900K. The default is Kelvin 6500K.

There are no pre-programmed types. The control parameters are:

Time

The time scale is 0.6 to 60 seconds. Time refers to how long it takes to scroll around the color wheel (0° to 360°)

Sat

The saturation scale is 0 to 100. With Saturation level of 0 = White and 100 = fully saturated.

General Settings

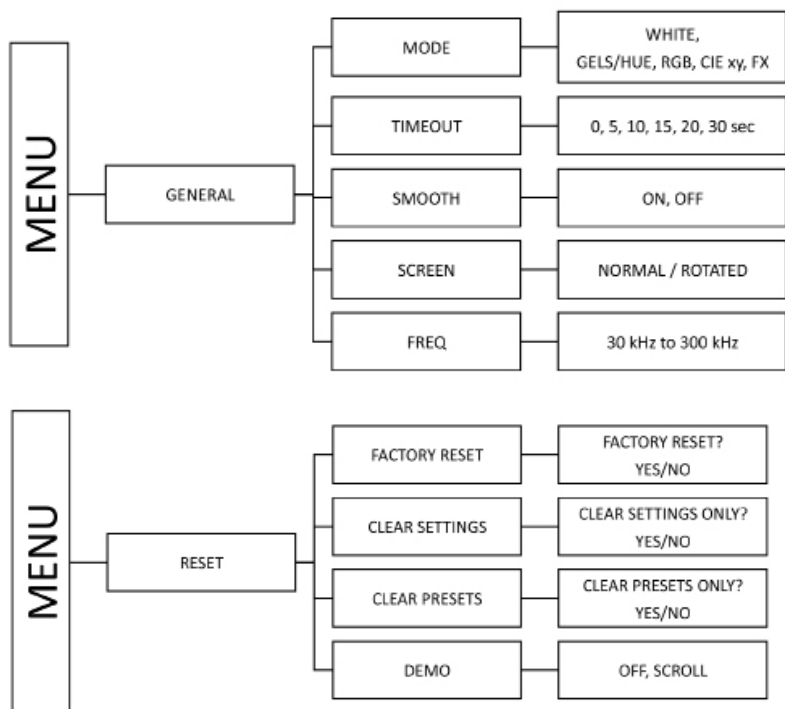



Mode: White, Gels/Hue, RGB, CIE xy or FX

Default is White mode. Custom Kelvin settings can be set between 2700K to 6500K. To change to Gels/Hue, RGB, CIE xy or FX mode, press the control knob. Custom Kelvin settings can be set between 2500K to 9900K.

Timeout

When choosing settings, if there is no activity, the display will default to Dim. The timeout default is 15 seconds, but can be changed by pressing the control knob to 0, 5, 15, 20 and 30 seconds.

Smooth

Default is **On**. Press control knob to turn Dim **Smooth Off** for instant response for special effects such as flashing, flickering, strobing, etc.

Screen Normal

Press control knob to rotate display.

Frequency

The default setting is 30kHz and is generally considered to be flicker-free for most applications up to 240 frames/per second. However, Frequency can be increased up to 300kHz by increments of 1.



Factory Reset

To reset factory settings, press the control knob to select **Reset**, press to select **Factory Reset**. Rotate the control knob to select Yes and press to confirm reset. Main display will default to: Dim = 10%, Kelvin = 2700K, G/M = 000 and DMX = 001.

Clear Settings

To clear all settings, but save any presets that have been stored to memory. Press the control knob to select clear settings. Rotate the control knob to select Yes and press to confirm.

Clear Presets:

To reset Preset buttons 1-4: 2700K, 3200K, 5000K, 6500K. In addition **G/M** will reset to 000. Press the control knob to select **Clear Presets**. Rotate the control knob press to select Yes and press to confirm.

Note: Clear Presets resets buttons in White mode, both Color modes, CIE xy and FX mode.

DMX Settings

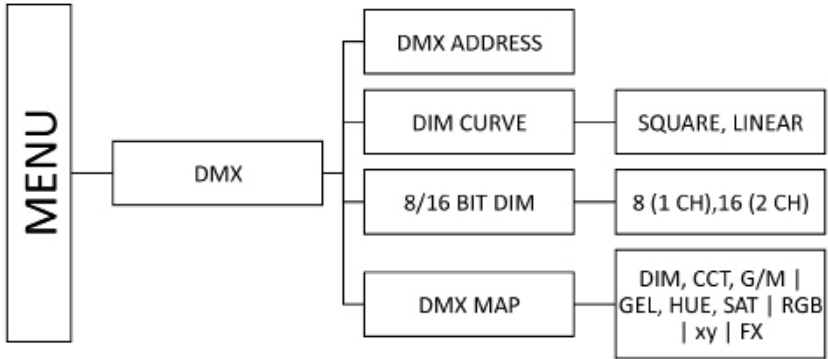

Press the Menu button to select **DMX**. Press and turn the control knob to select individual digit settings for a valid address from 1-512. On the main display, "X" next to DMX indicates DMX signal is present.

All manual controls are disabled once the DMX cable is applied and DMX is turned on. To regain manual control with the DMX cable plugged in, set the DMX address to "0".

For DMX mapping see Kino Flo website at www.kinoflo.com.

DMX



DMX

White Mode

In White mode, the fixture operates on three DMX channels using DMX512 while in the default 8 Bit Dim mode. The first channel operates dimming; 2nd channel operates Kelvin from 2700K to 6500K; 3rd channel operates G/M. Once an address is selected, the fixture automatically assigns 3 channels.

Gels/Hue Mode

In Gels/Hue mode, the fixture operates on six DMX channels while in the default 8 Bit Dim mode. The first channel operates dimming; 2nd channel operates Kelvin from 2500K to 9900K; 3rd channel operates G/M; 4th channel operates the Gel; 5th channel operates the Hue angle and the 6th channel operates the Saturation. Once an address is selected, the fixture automatically assigns 6 channels.

Note: In order to control the **Gel** list channel, the **G/M** channel needs to be set to 0. In order to control the **Hue** angle and **Saturation** channels, the **G/M** and **Gel** list channels both need to be set to 0.

RGB Mode

In RGB mode, the fixture operates on six DMX channels while in the default 8 Bit Dim mode. The first channel operates dimming; 2nd channel operates Kelvin from 2500K to 9900K; 3rd channel operates G/M; 4th channel operates Red; 5th channel operates Green and the 6th channel operates Blue. Once an address is selected, the fixture automatically assigns 6 channels.

Note: In order to control the **RGB** channels, the **G/M** channel needs to be set to 0.

CIE xy Mode

In CIE xy Mode, the fixture operates on three DMX channels using DMX512 while in the default 8 Bit Dim mode. The first channel operates dimming; 2nd channel operates x; 3rd channel operates y.

FX Mode

In FX (Effects) mode, the fixture operates on eight DMX channels using DMX512 while in the default 8 Bit Dim mode. The first channel operates dimming; 2nd channel operates the Effect, 3rd channel operates Kelvin from 2500K to 9900K (Fire and Candle – 1400K to 2500K); the 4th through 8th channels operate the Effect Parameters. For more information, see True Match Firmware 4.0 DMX Mapping.



DIM Curve

Default is **Square**. Press control knob to change to **Linear**. **Dim Curve** applies to how the input DMX Dim command is applied. In **Linear** mode an address of 127 = 50% Dim. Because single channel DMX is only 8 bit (0-255), the lower end of the Dim curve has the same increment as the higher end. **Square Dim** applies X^2 curve and allocates more values to the lower end of the Dim scale.

8/16 Bit DIM

Default is **8 Bit**. **16 Bit Dim** allocates an additional DMX channel for the Dim input, one channel for the upper 8 Bits and another channel for the lower 8 Bits.

DMX Map

In **White** mode, DMX Map displays three DMX channel settings for DIM, CCT (Kelvin) and G/M.

In **Gels/Hue Color** mode, DMX Map displays six DMX channel settings for DIM, CCT (Kelvin), G/M, Gel, Hue and Saturation.

In **RGB Color** mode, DMX Map displays six DMX channels settings for DIM, CCT (Kelvin), G/M, R (Red), G (Green) and B (Blue).

In **CIE xy** mode, DMX Map displays three DMX channel settings for DIM, CIE x and CIE y.

In **FX (Effects)** mode, DMX Map displays eight DMX channel settings for DIM, FX, CCT (Kelvin) and P1, P2, P3, P4 and P5 (Effect Parameters). For more information, see True Match Firmware 4.0 DMX Mapping.

Note: If **16 Bit Dim** is on, a total of 4 channels are displayed for **White** mode (7 channels displayed for **Gels/Hue** or **RGB Color** mode). The first 2 DMX channels are assigned to dimming. 1st channel = **DIM MSB** (Most Significant Byte); 2nd channel **DIM LSB** (Least Significant Byte); 3rd channel = CCT (Kelvin); 4th channel = G/M.

In **Gels/Hue Color** mode, 5th channel = Gel, 6th channel = Hue; 7th channel = Saturation. In **RGB Color** mode, 5th channel = R (Red), 6th channel = G (Green), 7th channel = B (Blue).

In **CIE xy** mode, the first 2 DMX channels are assigned to dimming (**DIM MSB**, **DIM LSB**); 3rd channel = CIE x; 4th channel = CIE y.

In **FX (Effects)** mode, the first 2 DMX channels are assigned to dimming (**DIM MSB**, **DIM LSB**); 3rd channel = FX; 4th channel = CCT (Kelvin); 5th through 9th channels = P1, P2, P3, P4, P5 (Effect Parameters).

If a fixture loses its DMX signal, it will hold its last DMX command. For this reason, it is important to turn a fixture off using the DMX commands. For example, if you try to turn off the lights by turning off the dimmer board, the lights will remember their last DMX command and stay on. The fixtures require a DMX "Off" or "Black-Out" command in order to turn off.

DMX Wireless Settings

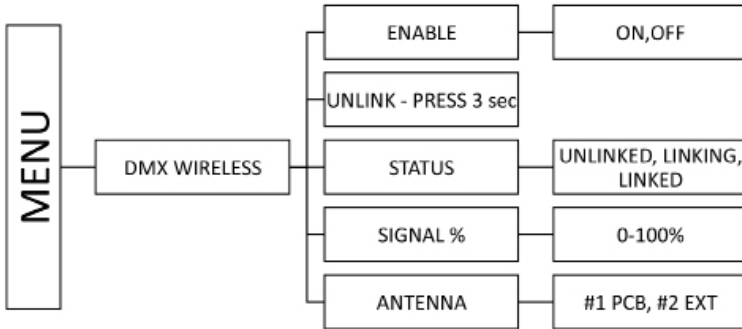

The LED Controller/Fixtures include a built-in Lumen Radio receiver and can be operated wirelessly with a Lumen Radio transmitter (sold separately). For more information on Lumen Radio Receiver/Transmitter, see www.LumenRadio.com.

DMX Wireless is an alternative to using DMX cables. Set DMX address as previously instructed on p 26. DMX protocol will only operate in one of two methods. User will need to choose between wireless or DMX cables.

Note: DMX fixtures without wireless capability can be daisy chained with DMX cables to a wireless fixture.



Enable

Enables wireless DMX. Default is **OFF**. Press the control knob to turn **Enable ON**. The following are examples of what will be seen in the main display when wireless DMX is Enabled:

- 1) **"R" with no signal bar**: Indicates wireless DMX is enabled, but there is no connection to a transmitter.
- 2) **"R" with signal bar**: Indicates wireless DMX is enabled; the fixture is connected to a transmitter, but no valid DMX is currently being transmitted.
- 3) **"RX" with signal bar**: Indicates wireless DMX is enabled; the fixture is connected to a transmitter and valid DMX is currently being transmitted.

All manual controls are disabled when wireless DMX is enabled.

Unlink - Press 3 secs

Press the control button for 3 seconds to unlink from wireless DMX transmitter.

Status – Unlinked, Linking, Linked

This shows the status of the wireless connection. Default is Unlinked. When linking is initiated from the transmitter, the status will display Linking. Once connected, the status will change to Linked. If the fixture is linked to a transmitter that is not present, the status will show Linking.

Signal

Indicates signal strength of wireless connection. In main display, up to 5 bars indicate signal strength.

Antenna

The default setting is #2 EXT (External). It can also be changed to #1 PCB (Printed Circuit Board)

Note: Controller/Fixture must be powered on. In addition, the wireless transmitter must be connected to a DMX controller with a valid DMX output.

Camera LUT

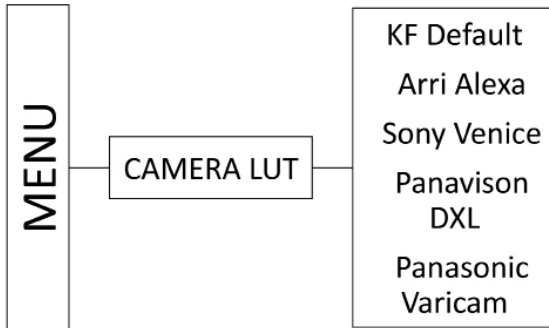

The **Camera LUT** (Look-up Tables) feature harmonizes the Kino Flo light sources to the camera. Depending on the camera and the Kelvin setting, some differences are very subtle, while others can be more dramatic.

The corrections are applied as a **CIE xy** correction at each CCT (Kelvin) setting. The default setting is targeting the CIE xyz response (human eye).

Press the green menu button to the left of the display screen and scroll down to **Camera LUT**, then press the control knob. Menu with camera selection will be displayed. Turn the control knob and press to select camera setting:

- C1 Arri Alexa**
- C2 Sony Venice**
- C3 Panavision DXL**
- C4 Panasonic Varicam**

The camera code (C1 for Arri Alexa), for example, will appear on the main menu between **DIM** and **CCT** to designate that a camera setting is active.

Note: When the controller is reset, the camera settings will go to Kino Flo Default mode.

Color Space

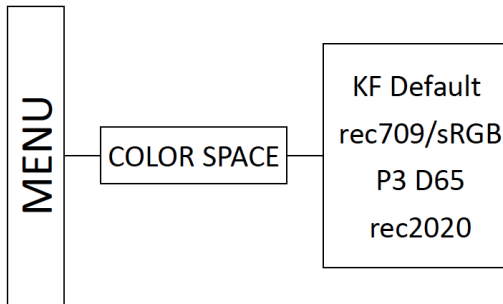

Color Space defines the RGB color space used and only affects color – not Kelvin. It is used in **RGB** mode and **Hue Angle** and **Saturation**. There are a few instances in the FX (Effects) mode that are also affected when color is used. The RGB color space defines the value of Red, Green, and Blue primaries (in CIE xy) and the white point is fixed at 6500 Kelvin.

Press the green menu button to the left of the display screen and scroll down to **Color Space**, then press the control knob. Menu with color selection will be displayed. Turn the control knob and press to select Color Space options:

rec 709 / sRGB
P3 D65
rec 2020

The color space **rec 709 / sRGB** is commonly used on computer monitors, SDTV and HDTV television. There are slight gamma variations between rec 709 / sRGB, but not enough to separate into 2 color spaces.

The color space **P3 D65** is a common color space for digital movie projection. The color space **rec 2020** is used in ultra high definition television (UHDTV).

The color space is used when the controller is set to the RGB mode and when set to the Hue Angle/ Saturation mode.

In **RGB** mode – the color space designation will be displayed at the top of the menu. When changing the Red, Blue or Green values, the Kelvin will be locked in at 6500 for all color spaces. When the Kelvin is locked in, CCT will be displayed as CCT*. When using Green/Magenta the CCT value is unlocked and color space selection has no impact.

In **Hue Angle/Saturation** mode – the color space designation will be displayed on the Gel line and GEL will be displayed as GEL* and CCT will be displayed as CCT*. The Color space will be displayed only when Hue Angle and Saturation are being used. When using Green/Magenta or Gel, the CCT will be unlocked and color space selection has no impact.

FCC Part 15 Verification:

This device complies with Part 15 of the FCC Rules. Operation is subject to the condition that this device does not cause harmful interference.

FCC Part 15 Declaration of Conformity:

This device complies with Part 15 of the FCC Rules. Operation is subject to the following two conditions: (1) this device may not cause harmful interference, and (2) this device must accept any interference received, including interference that may cause undesired operation.



KINO FLO, INC
Celeb 250,450,450Q,850, Diva-Lite 41/31/21, Diva-Lite 30/20,
FreeStyle T44/T42/T41/T24/T22/T21, FreeStyle 41/31/21/Mini,
Image L80/L40, Select 30/20.
ID: XRSCRMXTIMO101

For latest Warranty information and Certifications, see Kino Flo website at www.kinoflo.com..



Intertek

Environmental: Disposal of Old Electrical & Electronic Equipment.



This symbol on the product or on its packaging indicates that this product shall not be treated as household waste. This product is made of recyclable materials and should be disposed of in accordance with governmental regulations.

Kino Flo, Inc. 2840 N. Hollywood Way, Burbank, CA 91505, USA
Tel: 818 767-6528 website: www.kinoflo.com