



# LED Pixel Rail Drive 640 MKII controller

Musikhaus Thomann  
Thomann GmbH  
Hans-Thomann-Straße 1  
96138 Burgebrach  
Germany  
Telephone: +49 (0) 9546 9223-0  
E-mail: [info@thomann.de](mailto:info@thomann.de)  
Internet: [www.thomann.de](http://www.thomann.de)

12.02.2019, ID: 449740 (V3)

# Table of contents

<b>1</b>	<b>General information</b> .....	<b>5</b>
	1.1 Further information.....	6
	1.2 Notational conventions.....	7
	1.3 Symbols and signal words.....	7
<b>2</b>	<b>Safety instructions</b> .....	<b>9</b>
<b>3</b>	<b>Features</b> .....	<b>16</b>
<b>4</b>	<b>Installation and starting up</b> .....	<b>17</b>
<b>5</b>	<b>Connections and controls</b> .....	<b>23</b>
<b>6</b>	<b>Operating</b> .....	<b>28</b>
	6.1 Menu overview.....	33
	6.2 Functions in 10-channel DMX mode.....	34
	6.3 Functions in 55-channel DMX mode.....	35
	6.4 Network connection.....	36
<b>7</b>	<b>Technical specifications</b> .....	<b>37</b>
<b>8</b>	<b>Plug and connection assignment</b> .....	<b>39</b>

<b>9</b>	<b>Cleaning.....</b>	<b>41</b>
<b>10</b>	<b>Protecting the environment.....</b>	<b>42</b>

# 1 General information

This user manual contains important information on the safe operation of the device. Read and follow all safety notes and all instructions. Save this manual for future reference. Make sure that it is available to all persons using this device. If you sell the device to another user, be sure that they also receive this manual.

Our products and user manuals are subject to a process of continuous development. We therefore reserve the right to make changes without notice. Please refer to the latest version of the user manual which is ready for download under [www.thomann.de](http://www.thomann.de).

## 1.1 Further information

On our website ([www.thomann.de](http://www.thomann.de)) you will find lots of further information and details on the following points:

Download	This manual is also available as PDF file for you to download.
Keyword search	Use the search function in the electronic version to find the topics of interest for you quickly.
Online guides	Our online guides provide detailed information on technical basics and terms.
Personal consultation	For personal consultation please contact our technical hotline.
Service	If you have any problems with the device the customer service will gladly assist you.

## 1.2 Notational conventions

This manual uses the following notational conventions:

### Letterings

The letterings for connectors and controls are marked by square brackets and italics.

**Examples:** *[VOLUME]* control, *[Mono]* button.



### Displays

Texts and values displayed on the device are marked by quotation marks and italics.

**Examples:** *'24ch'*, *'OFF'*.

## 1.3 Symbols and signal words

In this section you will find an overview of the meaning of symbols and signal words that are used in this manual.

Signal word	Meaning
<b>DANGER!</b>	This combination of symbol and signal word indicates an immediate dangerous situation that will result in death or serious injury if it is not avoided.
<b>NOTICE!</b>	This combination of symbol and signal word indicates a possible dangerous situation that can result in material and environmental damage if it is not avoided.
Warning signs	Type of danger
	Warning – high-voltage.
	Warning – danger zone.



## 2 Safety instructions

### Intended use

This device is used to control Pixel Rail Strips (item no.: 449739). Use the device only as described in this user manual. Any other use or use under other operating conditions is considered to be improper and may result in personal injury or property damage. No liability will be assumed for damages resulting from improper use.

This device may be used only by persons with sufficient physical, sensorial, and intellectual abilities and having corresponding knowledge and experience. Other persons may use this device only if they are supervised or instructed by a person who is responsible for their safety.

### Safety



#### **DANGER!**

#### **Danger for children**

Ensure that plastic bags, packaging, etc. are disposed of properly and are not within reach of babies and young children. Choking hazard!

Ensure that children do not detach any small parts (e.g. knobs or the like) from the unit. They could swallow the pieces and choke!

Never let children unattended use electrical devices.



**DANGER!**

**Electric shock caused by high voltages inside**

Within the device there are areas where high voltages may be present. Never remove any covers.

There are no user-serviceable parts inside.

Do not use the device if covers, protectors or optical components are missing or damaged.



**DANGER!**

**Electric shock caused by short-circuit**

Always use proper ready-made insulated mains cabling (power cord) with a protective contact plug. Do not modify the mains cable or the plug. Failure to do so could result in electric shock/death or fire. If in doubt, seek advice from a registered electrician.



**NOTICE!**

**Risk of fire**

Do not block areas of ventilation. Do not install the device near any direct heat source. Keep the device away from naked flames.



### **NOTICE!**

#### **Operating conditions**

This device has been designed for indoor use only. To prevent damage, never expose the device to any liquid or moisture. Avoid direct sunlight, heavy dirt, and strong vibrations.

Only operate the device within the ambient conditions specified in the chapter 'Technical specifications' of this user manual. Avoid heavy temperature fluctuations and do not switch the device on immediately after it was exposed to temperature fluctuations (for example after transport at low outside temperatures).

Dust and dirt inside can damage the unit. When operated in harmful ambient conditions (dust, smoke, nicotine, fog, etc.), the unit should be maintained by qualified service personnel at regular intervals to prevent overheating and other malfunction.



**NOTICE!**

**Power supply**

Before connecting the device, ensure that the input voltage (AC outlet) matches the voltage rating of the device and that the AC outlet is protected by a residual current circuit breaker. Failure to do so could result in damage to the device and possibly injure the user.

Unplug the device before electrical storms occur and when it is unused for long periods of time to reduce the risk of electric shock or fire.



**NOTICE!**

**Possible damage due to installation of a wrong fuse**

The use of different types of fuses can cause serious damage to the unit. Fire hazard!

Only fuses of the same type may be used.



### **NOTICE!**

#### **Possible staining**

The plasticiser contained in the rubber feet of this product may possibly react with the coating of your parquet, linoleum, laminate or PVC floor and after some time cause permanent dark stains.

In case of doubt, do not put the rubber feet directly on the floor, but use felt-pad floor protectors or a carpet.



### **NOTICE!**

#### **Wiring**

Follow the wiring instructions in this manual.



**NOTICE!**

**Compatible devices**

The device may only be used with Stairville Pixel Rail 40 RGB MKII (item no. 449739).

### 3 Features

- Controller for up to 16 pixel rail strips (maximum four per output) of the type Stairville LED Pixel Rail 40 RGB MKII (Item no.: 449739)
- Control protocols: DMX (10/55 channels), ArtNet (4x480 channels), RDM
- Operating modes: Stand Alone (30 programmes), Master / slave
- In and outputs: DMX, RJ45 (ArtNet)
- Operating via buttons and display on the unit
- Lockable connections (Power Twist) for self-supply and to supply further devices
- Convection cooling
- Robust die-cast aluminium housing, black



## 4 Installation and starting up

Unpack and check carefully there is no transportation damage before using the unit. Keep the equipment packaging. To fully protect the product against vibration, dust and moisture during transportation or storage use the original packaging or your own packaging material suitable for transport or storage, respectively.

The device has two lateral attachment lugs each with two slots for wall or ceiling mounting (mounting hardware not included).

Make sure that the installation complies with the standards and rules that apply in your country.

Connect the units to be controlled via suitable DMX or RJ45 data cable to the device. A maximum of 30 additional DMX devices may be serially connected to each serial port.

Create all connections while the device is off. Use the shortest possible high-quality cables for all connections. Take care when running the cables to prevent tripping hazards.

## Connection examples

The following figures show the connection configuration of the pixel strips in the various operating modes.

### Master / Slave operation

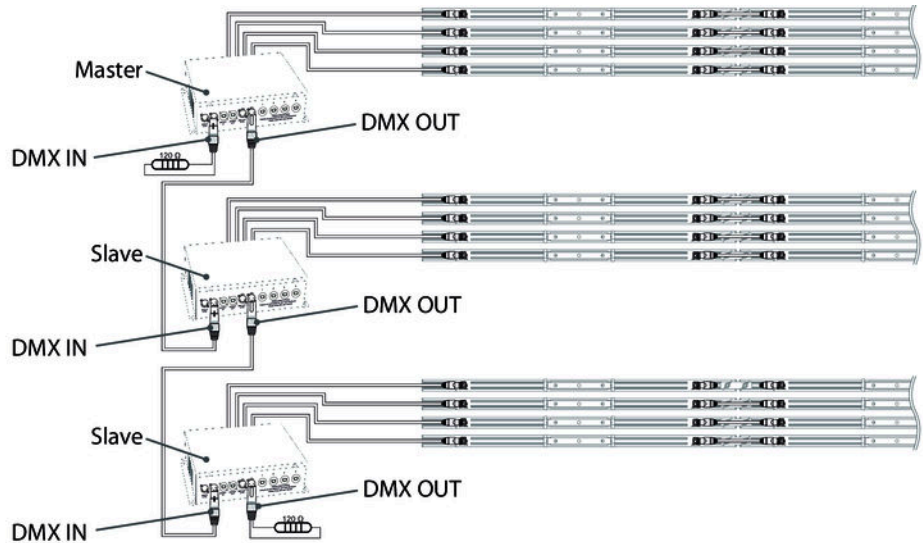

## Control via ArtNet

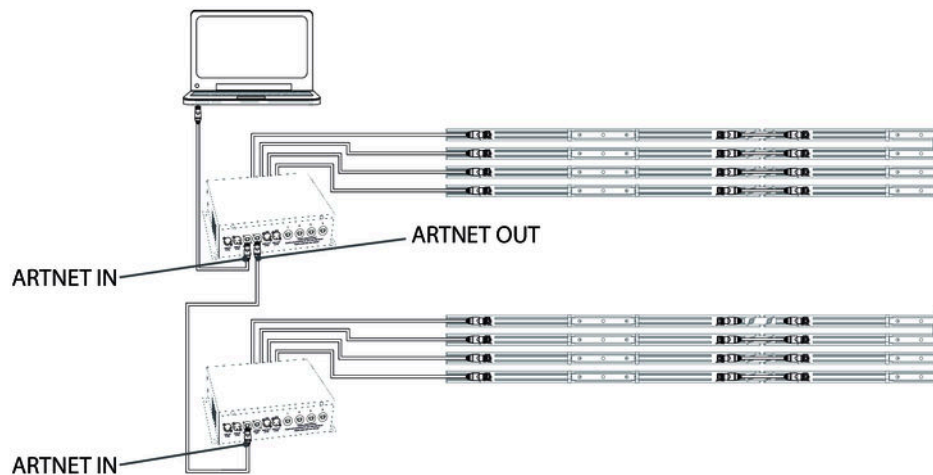

LED Pixel Rail Drive 640 MKII

Control via DMX

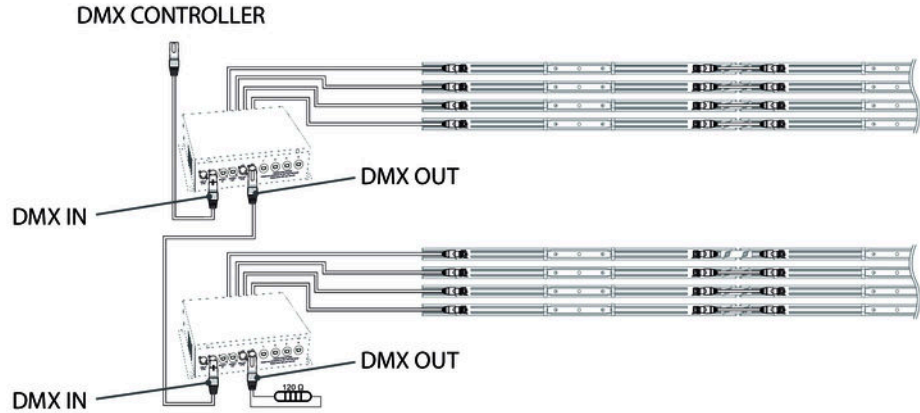



**NOTICE!**

**Possible data transmission errors**

For error-free operation make use of dedicated DMX cables and do not use ordinary microphone cables.

Never connect the DMX input or output to audio devices such as mixers or amplifiers.

## Notes on wiring

The following figure shows the maximum permissible cable lengths. A maximum of four Stairville LED Pixel Rail 40 RGB MKII may be connected per output.

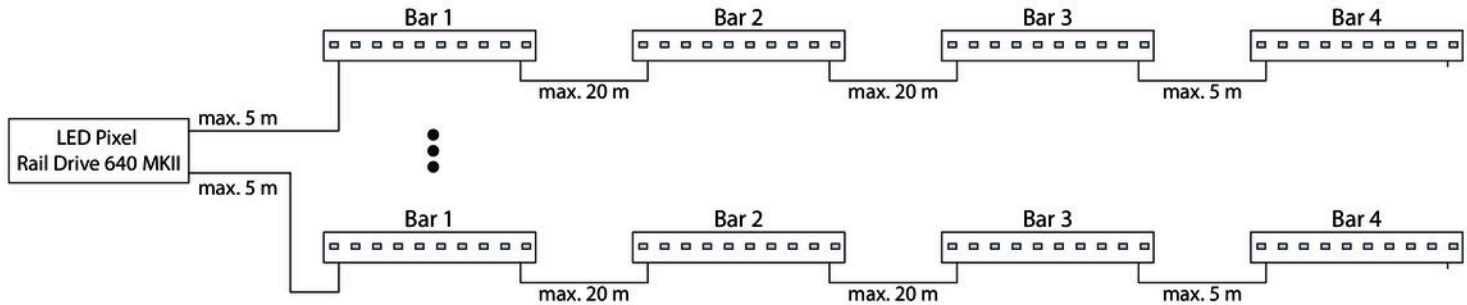

## 5 Connections and controls

### Front panel

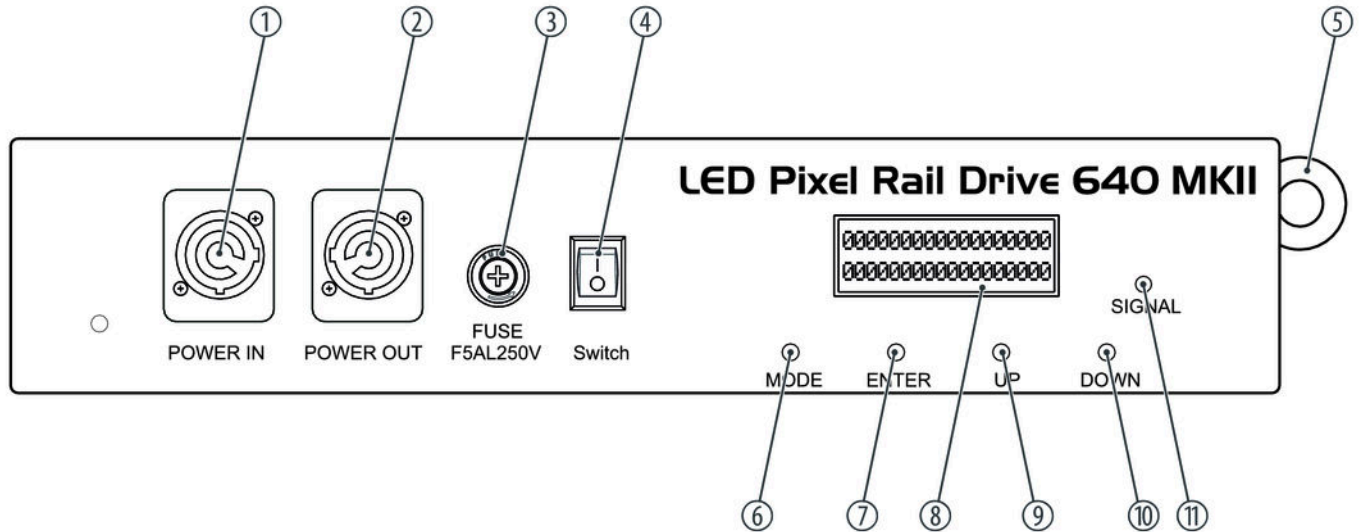

LED Pixel Rail Drive 640 MKII

1	<i>[POWER IN]</i> Lockable input socket (Power Twist) for power supply
2	<i>[POWER OUT]</i> Lockable output socket (Power Twist) for the power supply of further units.
3	Fuse holder
4	<i>[Switch]</i> Main switch to turn the device on and off.
5	Safety cable eyelet.
6	<i>[MODE]</i> Activates the main menu and toggles between menu items. Closes an opened sub menu.
7	<i>[ENTER]</i> Selects an option of the respective operating mode, confirms the set value.
8	Display



---

9	<i>[UP]</i> Increases the displayed value by one.
10	<i>[DOWN]</i> Decreases the displayed value by one.
11	<i>[SIGNAL]</i> Indicator LED. This LED lights up on incoming signal.

Rear panel

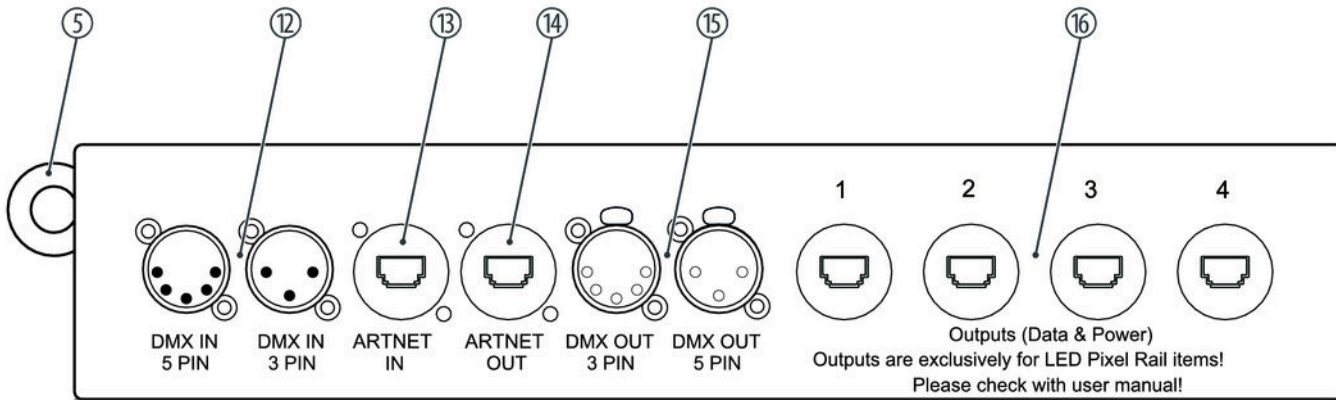

12	<i>[DMX IN]</i> DMX input (3 and 5-pin) to control the device via DMX.
13	<i>[ARTNET IN]</i> RJ45 input to control the device via ArtNet.
14	<i>[ARTNET OUT]</i> RJ45 output to control other devices via ArtNet.
15	<i>[DMX OUT]</i> DMX output (3 and 5-pin) for connecting additional DMX devices in a DMX universe.
16	<i>[Outputs]</i> RJ45 outputs for controlling the pixel strips via LAN cable. A maximum of four Stairville LED Pixel Rail 40 RGB MKII can be connected per output.

## 6 Operating

Connect the device to the power grid and turn it on with the main switch *[Switch]*.

### Operating mode Auto

Automatic operation can only be activated when the unit is operating alone or as master in a master / slave combination. This setting is only relevant if the device is not controlled via DMX or ArtNet.

Press *[MODE]* and use the buttons *[UP]* and *[DOWN]* to select the 'Auto Mode' option. Confirm with *[ENTER]* to open the 'Auto Mode' menu.

Here you can activate one of 30 available show programmes and set the programme speed.

Use the buttons *[UP]* and *[DOWN]* to select the desired option and confirm with *[ENTER]*. Adjust the displayed value with *[UP]* and *[DOWN]* and press Enter to confirm each new setting. *[ENTER]*.

With *[MODE]* you return to the previous menu level.

Parameter	Function
Speed	Programme speed, value range '1' ... '9' (slow ... fast).
Program	Programme selection, value range '01' ... '29', 'Mix'.

## DMX address

This setting is only relevant when the device is controlled via DMX.

Press *[MODE]* and use the buttons *[UP]* and *[DOWN]* to select the 'DMX Address' option. Confirm with *[ENTER]* to open the 'DMX Address' menu.

Use *[UP]* or *[DOWN]* to specify the desired DMX address in a range from '001' ... '512' and press ENTER to confirm the new setting *[ENTER]*. If more than one Pixel Rail driver are used, each device uses 8 DMX channels. The first controller, for example, occupies address 1 to 8. The second controller must be set accordingly to address 9, the third controller to address 18, etc.

In 8-channel operation, the address 009 must be assigned to the first controller, the address 018 to the second, etc.

With *[MODE]* you return to the previous menu level.

### **Software info**

This menu offers you the option to display the currently installed software version.

Press *[MODE]* and use the buttons *[UP]* and *[DOWN]* to select the 'Software Version' option.

Confirm with *[ENTER]* to display the version information.

With *[MODE]* you return to the previous menu level.

### **Length and number of the pixel strips**

In this menu you determine the length and thus the number of possible pixel strips per output.

Press *[MODE]* and use the buttons *[UP]* and *[DOWN]* to select the 'Length' option. Confirm with *[ENTER]* to open the 'Length' menu.

Use *[UP]* or *[DOWN]* to set the desired length in a range of '1M' ... '4M' (1 meter / one strip per output ... 4 meters / four strips per output) and confirm the new setting with *[ENTER]*.

With *[MODE]* you return to the previous menu level.

## Network settings

In this menu you determine the network settings.

Press *[MODE]* and use the buttons *[UP]* and *[DOWN]* to select the 'Network Settings' option. Confirm with *[ENTER]* to open the 'Network Settings' menu.

Use the buttons *[UP]* and *[DOWN]* to select the desired option and confirm with *[ENTER]*. Adjust the displayed value with *[UP]* and *[DOWN]* and press Enter to confirm each new setting. *[ENTER]*.

Parameter	Function
IP Address	IP address
Subnet Mask	Subnet mask
Net SubNet Unive	DMX universe

### **Operating mode Slave**

This setting is only relevant if the device is controlled via DMX and working as slave in a master / slave configuration.

Press *[MODE]* and use the buttons *[UP]* and *[DOWN]* to select the 'Slave Mode' option.

Confirm with *[ENTER]* and use *[UP]* and *[DOWN]* to select the 'YES' option. Then the device operates in Slave mode.

With *[MODE]* you return to the previous menu level.



## 6.1 Menu overview

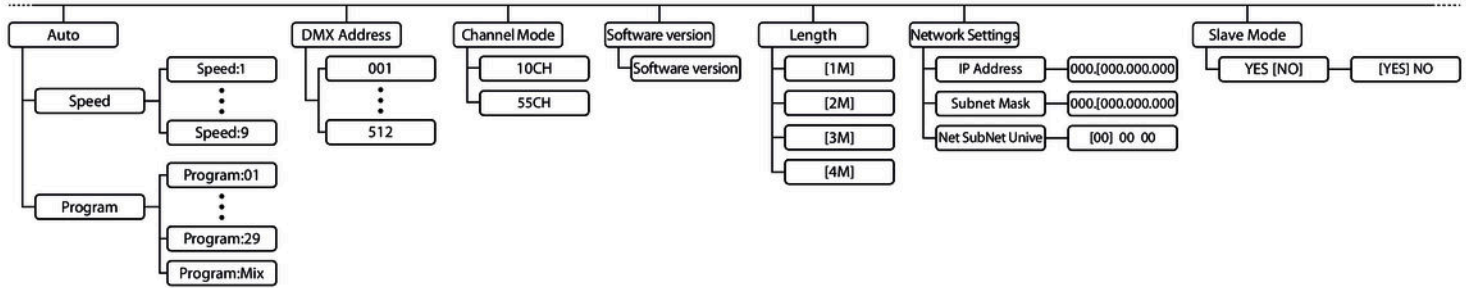

## 6.2 Functions in 10-channel DMX mode

Channel	Value	Function
1	0 ... 255	Dimmer function (0 % ... 100 %)
2	0 ... 255	Strobe effect (slow ... fast)
3	0 ... 255	Intensity red LED (0 % ... 100 %)
4	0 ... 255	Intensity green LED (0 % ... 100 %)
5	0 ... 255	Intensity blue LED (0 % ... 100 %)
6	0 ... 255	Automatic programme 1 (multi colour effect. The last effect will be played automatically.)
7	0 ... 255	Automatic programme 2 (colour effect. The colour can be selected with CH9. The last effect will be played automatically.)
8	0 ... 255	Programme speed (slow ... fast)
9	0 ... 255	Colour selection for colour effect in the automatic programme
10	0 ... 255	Microphone sensitivity for sound control (low to high)

### 6.3 Functions in 55-channel DMX mode

Channel	Value	Function
1	0 ... 255	Dimmer function (0 % ... 100 %)
2	0 ... 255	Strobe effect (slow ... fast)
3	0 ... 255	Automatic programme 1 (multi colour effect. The last effect will be played automatically.)
4	0 ... 255	Automatic programme 2 (colour effect. The colour can be selected with CH9. The last effect will be played automatically.)
5	0 ... 255	Programme speed (slow ... fast)
6	0 ... 255	Colour selection for colour effect in the automatic programme
7	0 ... 255	Microphone sensitivity for sound control (low to high)
8	0 ... 255	Intensity red, first spotlight at the first output
9	0 ... 255	Intensity green, first spotlight at the first output
10	0 ... 255	Intensity blue, first spotlight at the first output

Channel	Value	Function
...		
55	0 ... 255	Intensity blue, fourth spotlight at the fourth output

## 6.4 Network connection

### ArtNet

For operation via ArtNet, first install the necessary software on your PC (Windows or Mac with fixed IP address). Connect the pixel rail strips to the controller and switch it on. Give the controller an IP address corresponding to the ArtNet settings. Set the subnet mask of the controller and the software to '255.0.0.0'.

Connect the controller to your PC. The software automatically recognizes all connected devices.

## 7 Technical specifications

Control protocols	DMX (10/55 channels) ArtNet (4x480 channels) RDM	
Number of DMX channels	10 or 55, depending on operating mode	
Input connections	DMX control	XLR chassis sockets, 3 and 5-pin
	ArtNet control	RJ45
	Voltage supply	Power Twist
Output connections	DMX control	XLR chassis sockets, 3 and 5-pin
	ArtNet control	RJ45
	Control of further pixel strips	RJ45
	Power supply for further controllers	Power Twist
Dimmer	0 ... 100 %	

## Technical specifications

---

Strobe effect	0 ... 25 Hz	
Cable length	max. 80 m (CAT6 cable)	
Power consumption	max. 400 W	
Operating supply voltage	100 – 240 V ~ 50/60 Hz	
Fuse	5 mm × 20 mm, 5 A, 250 V, fast-acting	
Protection class	IP20	
Dimensions (W × H × D)	305 mm × 230 mm × 65 mm	
Weight	2.5 kg	
Ambient conditions	Temperature range	0 °C...40 °C
	Relative humidity	50 %, non-condensing

## 8 Plug and connection assignment

### Introduction

This chapter will help you select the right cables and plugs to connect your valuable equipment so that a perfect light experience is guaranteed.

Please take our tips, because especially in 'Sound & Light' caution is indicated: Even if a plug fits into a socket, the result of an incorrect connection may be a destroyed DMX controller, a short circuit or 'just' a not working light show!

### DMX connections



The unit offers a 3-pin XLR socket for DMX output and a 3-pin XLR plug for DMX input. Please refer to the drawing and table below for the pin assignment of a suitable XLR plug.

Pin	Configuration
1	Ground, shielding
2	Signal inverted (DMX-, 'cold signal')
3	Signal (DMX+, 'hot signal')

### DMX connections



A five-pin XLR socket serves as DMX output, a five-pin XLR plug serves as DMX input. The drawing below and the table show the pin assignment of a matching coupling.

Pin	Assignment
1	Ground (shielding)
2	Signal inverted (DMX-, 'cold')
3	Signal (DMX+, 'hot')
4	unused / second connection (DMX-)
5	unused / second connection (DMX+)



## 9 Cleaning

### Device components

Clean the device components that are accessible from the outside regularly. The cleaning frequency depends on the operating environment: damp, smoky or particularly dirty environments can cause greater accumulation of dirt on the device components.

- Clean with a dry soft cloth.
- Stubborn dirt can be removed with a slightly dampened cloth.
- Never use solvents or alcohol for cleaning.

## 10 Protecting the environment

### Disposal of the packaging material



For the transport and protective packaging, environmentally friendly materials have been chosen that can be supplied to normal recycling.

Ensure that plastic bags, packaging, etc. are properly disposed of.

Do not just dispose of these materials with your normal household waste, but make sure that they are collected for recycling. Please follow the notes and markings on the packaging.

### Disposal of your old device



This product is subject to the European Waste Electrical and Electronic Equipment Directive (WEEE) in its currently valid version. Do not dispose with your normal household waste.

Dispose of this device through an approved waste disposal firm or through your local waste facility. When discarding the device, comply with the rules and regulations that apply in your country. If in doubt, consult your local waste disposal facility.



